

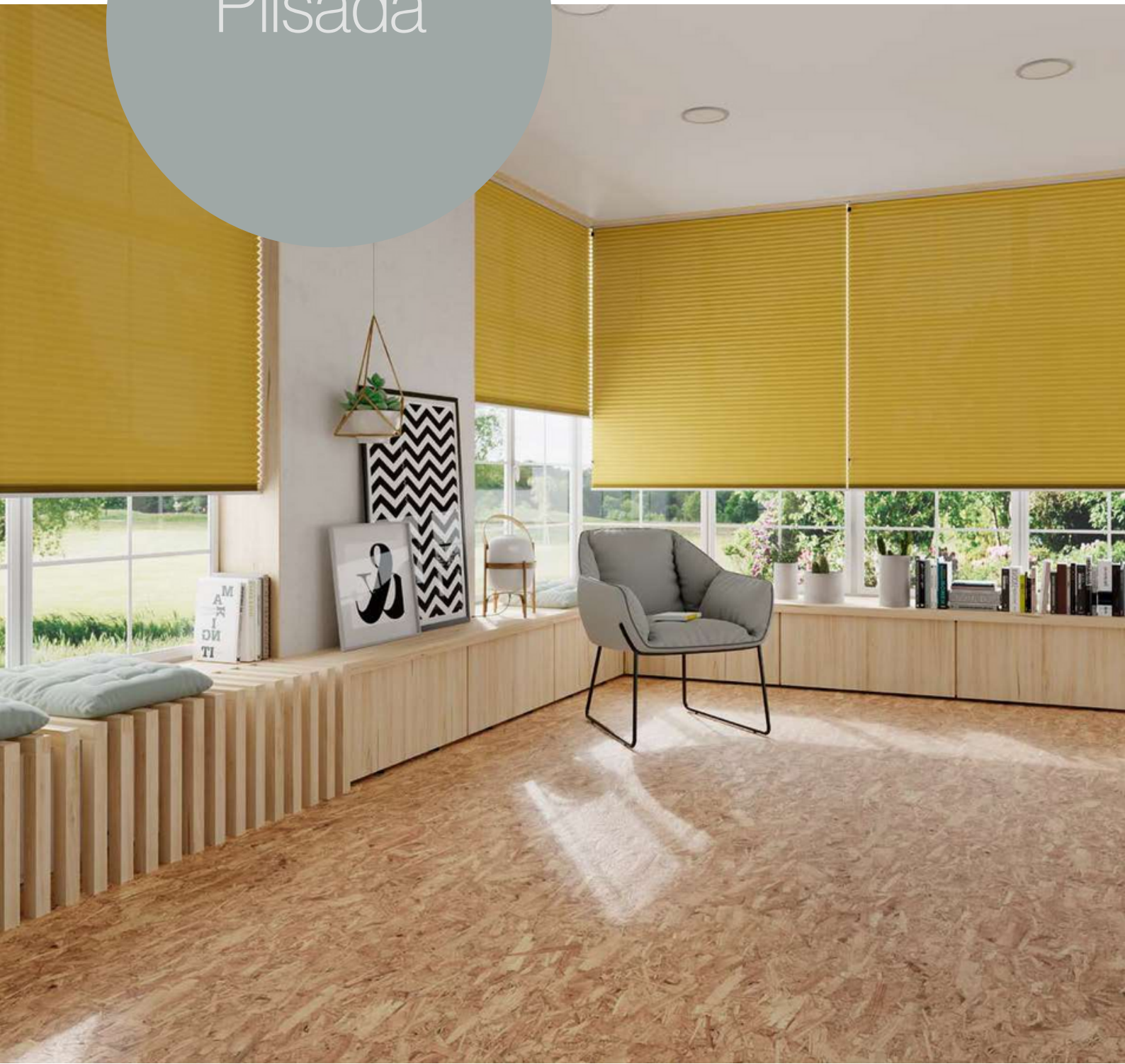

965 795 801 [www.tol2javea.com](http://www.tol2javea.com)

Ficha técnica

# Plisada



# Modelos

## Sistema 20 mm

029001 Sistema de 20 mm

029030 Sistema de 25 mm



### Componentes

Nº	Cód.	Descripción	Nº	Cód.	Descripción
1	029210	Mecanismo Plisada	7	029205	Cordón plisada 1:2
2	029206	Tapón perfil superior	8	029212	Igualador Plisada
3	029217	Perfil aluminio	9	029202	Soporte techo plisada sistema cordón
4	029216	Perfil PVC	10	029226	Escuadra soporte pared Plisada
5	029215	Pasa cordón	11	029227	Escuadra separación Plisada
6	029209	Tapón perfil inferior	12	029203	Cordón Plisada 0,8

### Medidas de fabricación

#### Máximos

Ancho	<b>2,30 m</b>
Alto	<b>3,00 m</b>

#### Mínimos

Ancho	<b>0,30 m</b>
Alto	<b>0,30 m</b>



# Tipos de sistemas

## Sistema a cadena

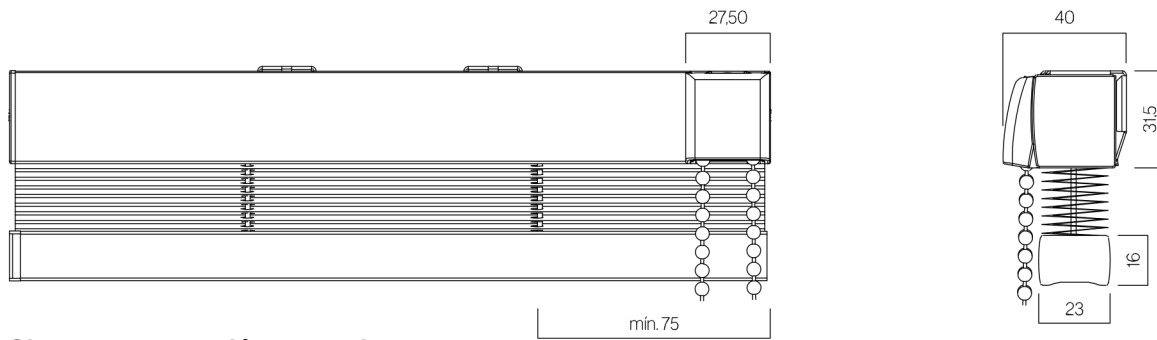

## Sistema con tensión manual

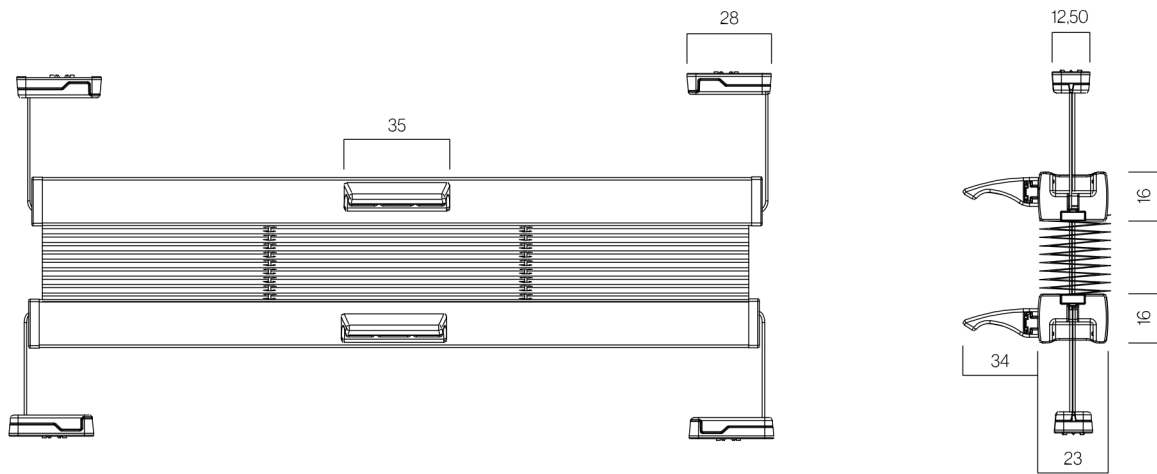

## Sistema a cordón

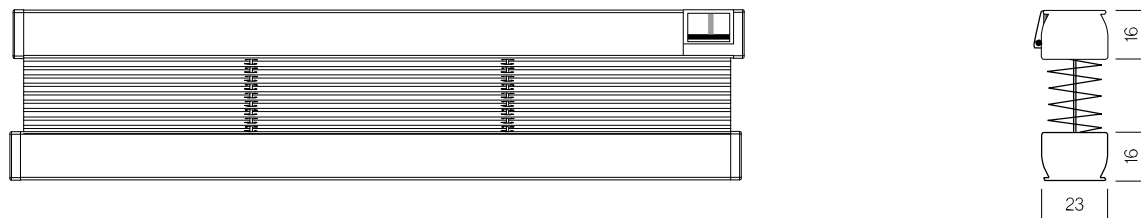

# Soportes

## Soportes para instalaciones a techo y a pared

Soporte techo  
029202

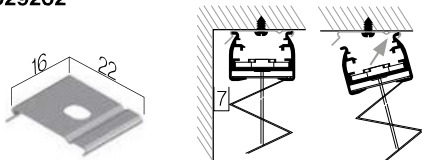

Escuadra separador  
029227

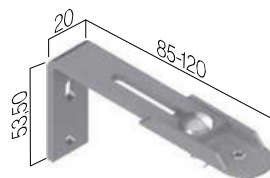

Soporte pared  
029226

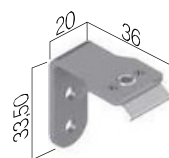

## Soporte para cortina de cristal

Soporte superior

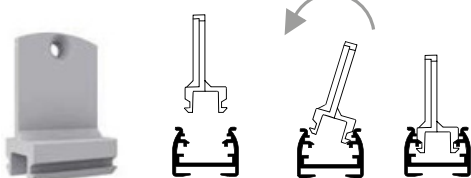

Jgo. soporte inferior

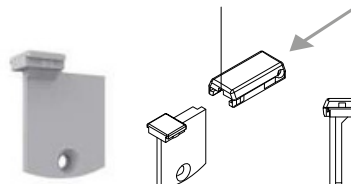

Tapa soporte



Medidas en mm.



## Tipos de configuración

### Configuraciones

Mecanismo a cordón.  
Con guías laterales  
(cordón).

Mecanismo doble  
cordón. Noche/día.

Accionamiento manual.  
Con guías laterales  
(cordón).

Accionamiento manual. Cierre  
arriba/abajo  
y abajo/arriba. Perfil de montaje  
superior.

101

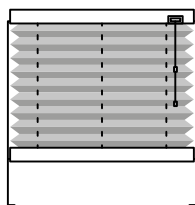

119

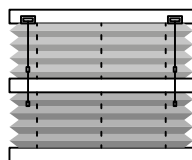

111

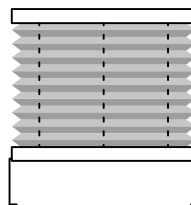

112

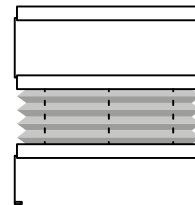

Accionamiento manual.  
Noche/día.

Accionamiento manual. Con  
perfil de montaje inferior.

Accionamiento manual. No-  
che/día con apertura central.

Accionamiento manual.  
Cierre arriba/abajo  
y abajo/arriba. Perfil de mon-  
taje superior e inferior.

113

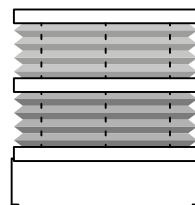

115

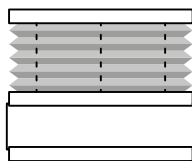

116

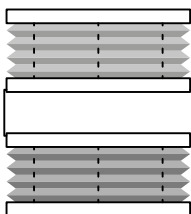

117

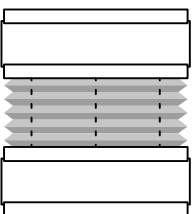

### Configuraciones

Accionamiento ma-  
nual. Noche/día con  
perfil de montaje  
inferior.

Accionamiento  
manual. Apertura  
central.

Accionamiento  
manual. Cierre arri-  
ba/abajo y abajo/  
arriba.

Máximo 1,30 ancho

Máximo 0,70 ancho

Máximo 1,30 ancho

118

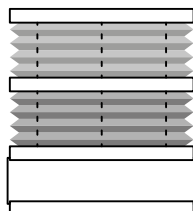

120

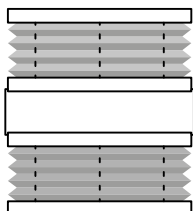

140

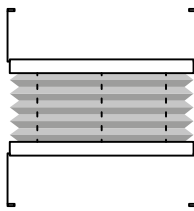

121



121

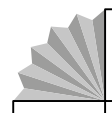

122

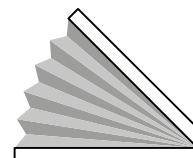

## Características técnicas

### Ancho máximo según el tipo de configuración

Nº configuración

Ancho máximo

111 • 112 • 113 • 114 • 115 • 116 • 117 • 118 • 119 • 120 • 140

1,20 m

## Plisada Glass

029300 Sistema de 20 mm  
Configuración 111 y 140

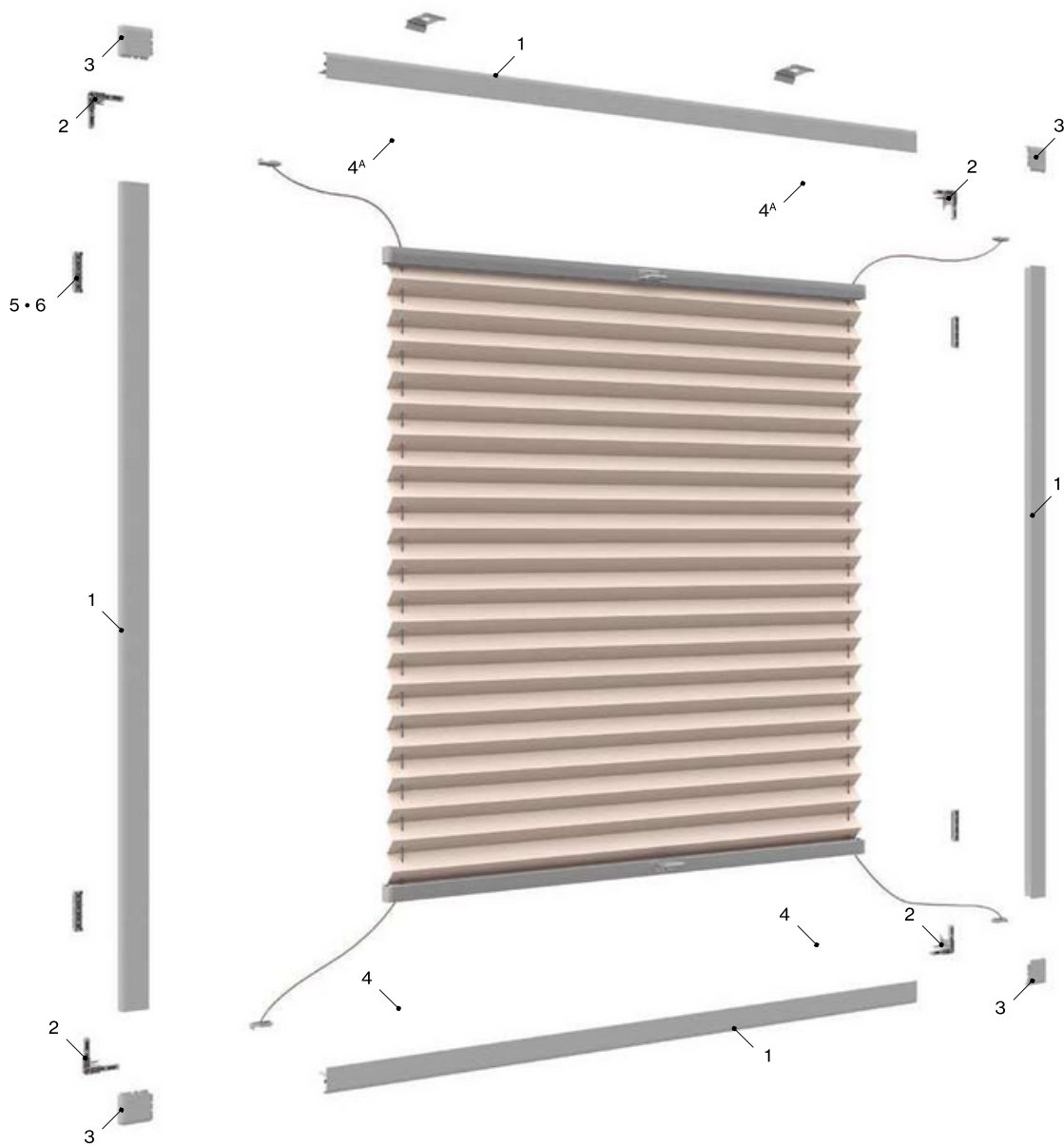

### Componentes

Nº	Cód.	Descripción	Nº	Cód.	Descripción
1	031241	Perfil fácil ajuste 580 cm XS	4 <sup>A</sup>	031244	Tension shoe XS (configuración 140)
2	031242	Unión esquina XS	5	031251	Clip sujeción ventana XS
3	031243	Cubierta esquina white ABS XS	6	031253	Cinta sujeción ventana XS
4	031244	Tension shoe XS	7	029202	Soporte techo plisada sistema cordón

### Medidas de fabricación

#### Máximos

Ancho	<b>1,20 m</b>
Alto	<b>2,40 m</b>

#### Mínimos

Ancho	<b>0,30 m</b>
Alto	<b>0,30 m</b>

 Modelos

## Plisada 27 Especial

029040 Sistema de 27 mm

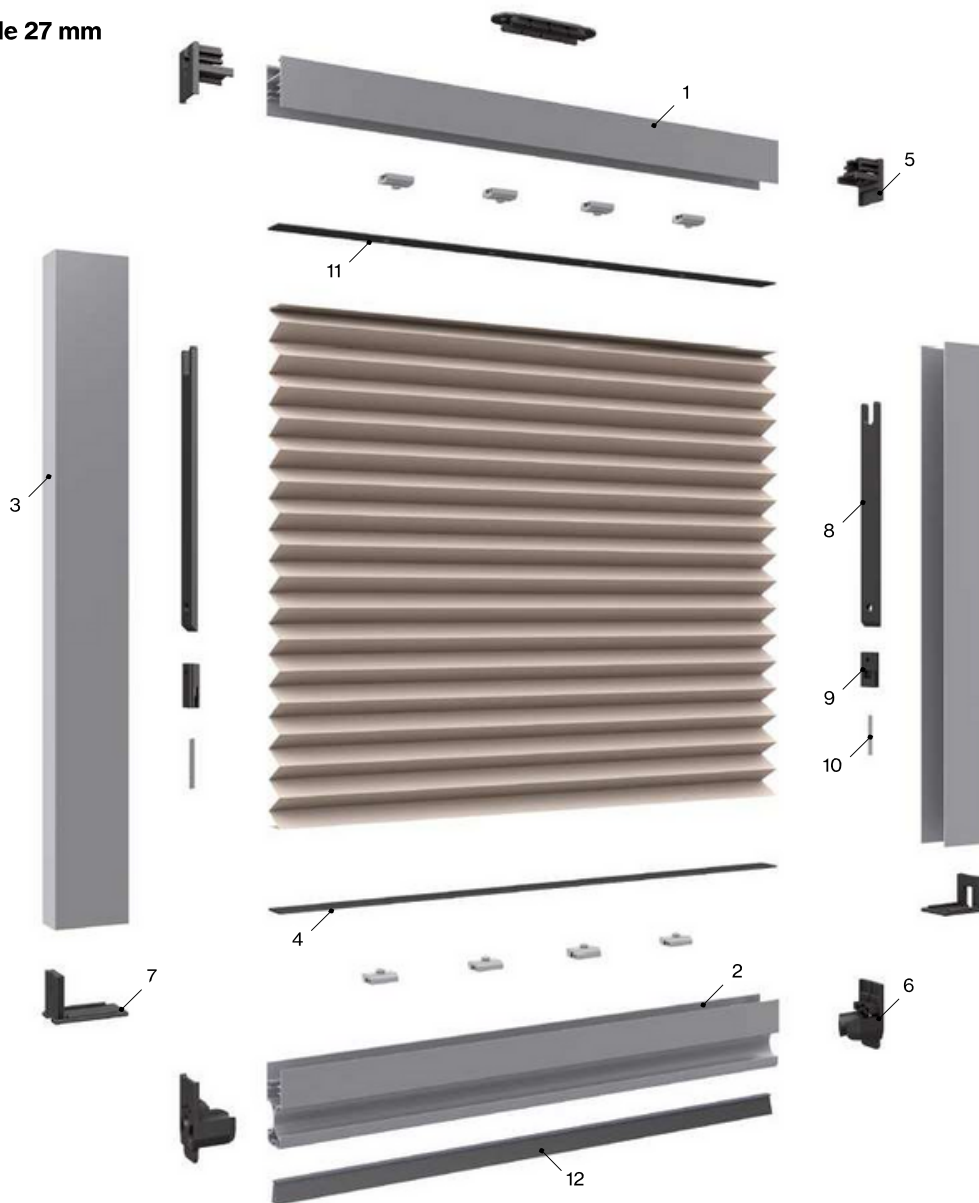

### Componentes

Nº	Cód.	Descripción	Nº	Cód.	Descripción
1	042098	Perfil fijo 27	8	042126	Tope testero c/tornillo Vertical 27
2	042096	Perfil móvil 27	9	042113	Sujeción hilo con tuerca remachable 27
3	042099	Guía superior 27	10	042127	Muelle 27
4	042082	Tira PVC anclaje red H260	11	042084	Clip central 27
5	042124	Testero superior perfil fijo 27	12	042805	Felpudo 58-900
6	042125	Testero superior perfil pared	13	042023	Soporte mosquitera plisada
7	042123	Tapón inferior Vertical 27			

### Medidas de fabricación

Máximos		Mínimos	
Ancho	1,60 m	Ancho	0,40 m
Alto	2,60 m	Alto	0,40 m



# Características técnicas

## Perfiles

Perfil móvil 27  
**042096**

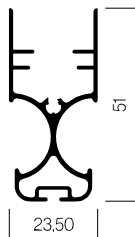

Guía superior 27  
**042099**

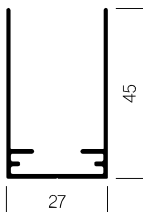

Perfil fijo 27  
**042098**

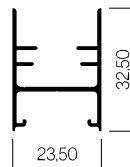

Guía Avant  
**031241**

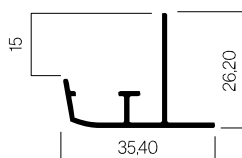

Tu mundo,  
nuestro universo.

