

Ficha técnica

Plisada

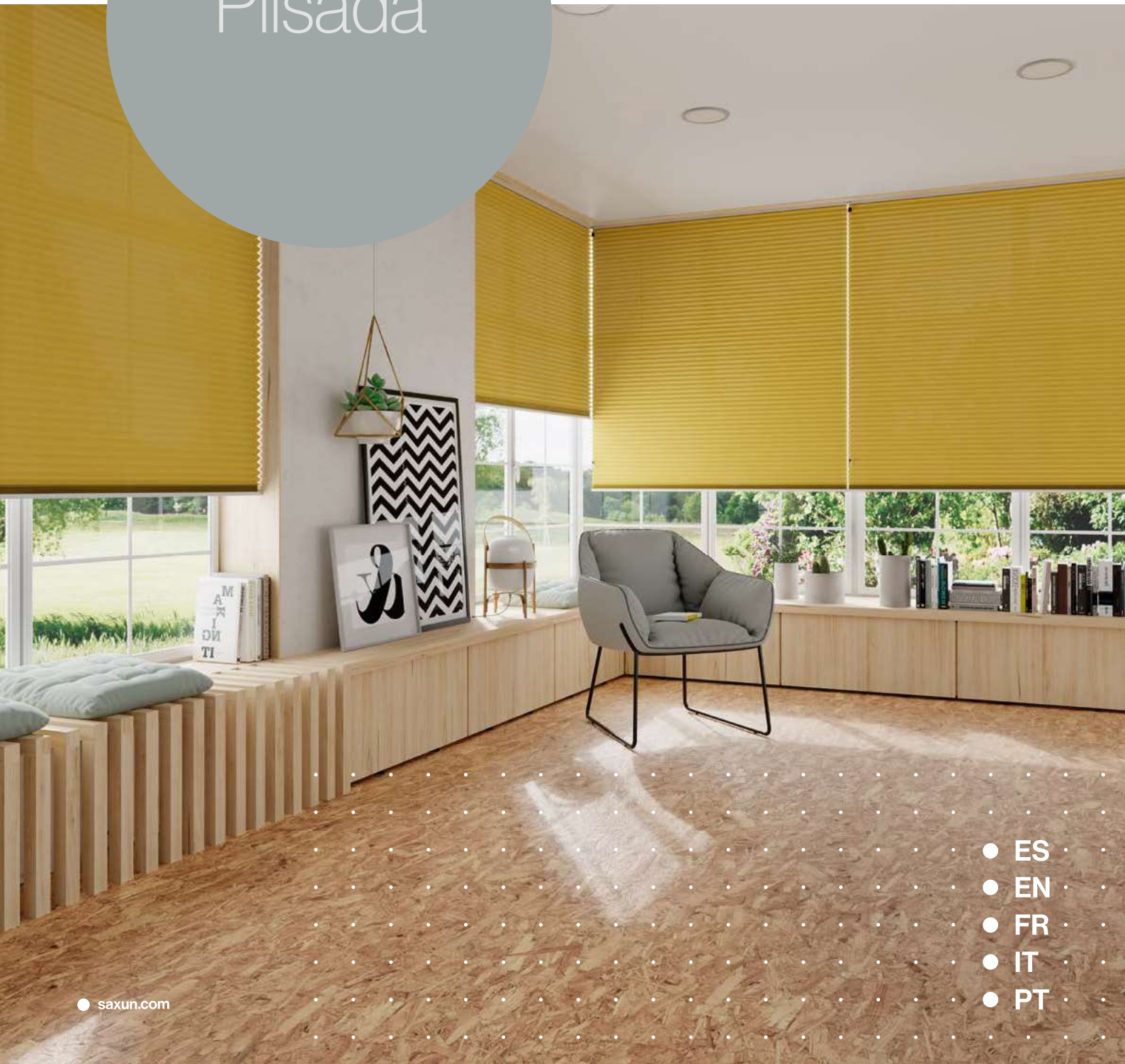

Modelos

Sistema 20 mm

029001 Sistema de 20 mm

029030 Sistema de 25 mm

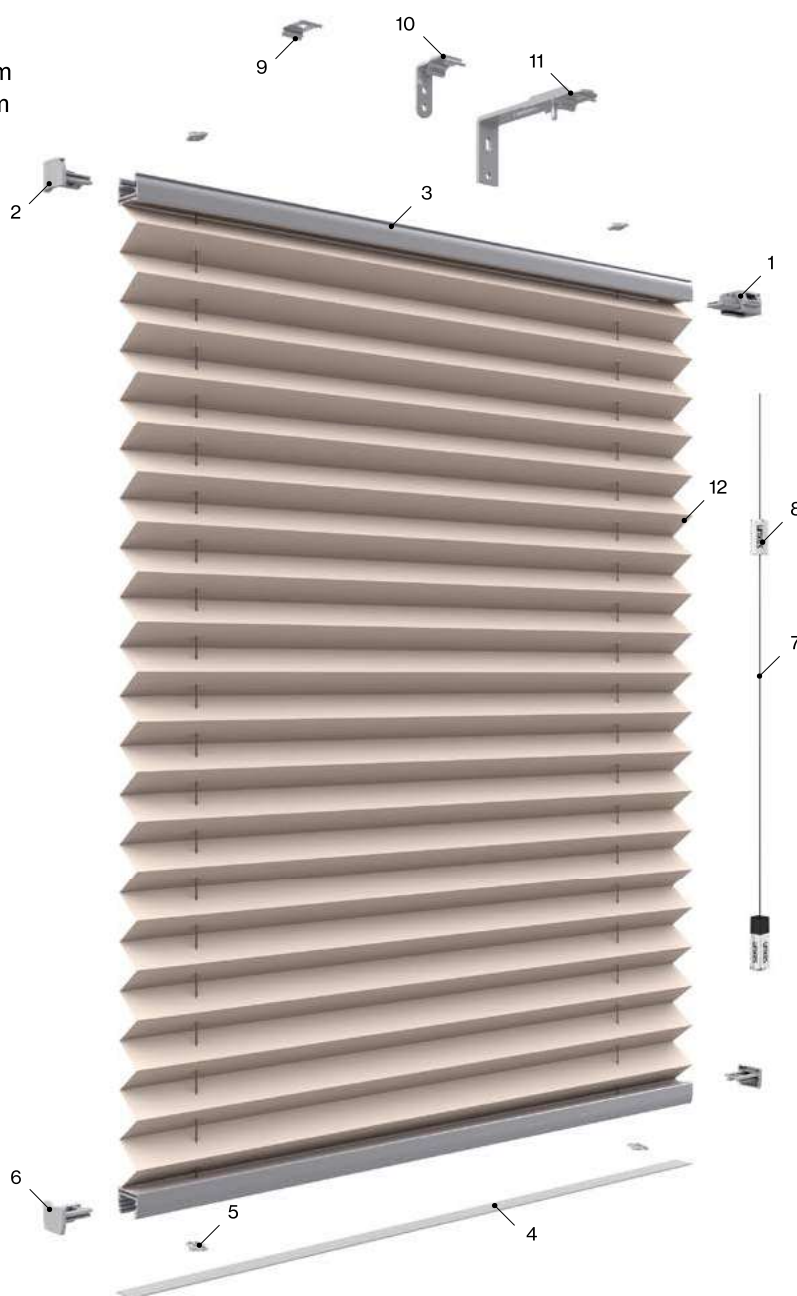

Componentes

Nº	Cód.	Descripción	Nº	Cód.	Descripción
1	029210	Mecanismo Plisada	7	029205	Cordón plisada 1:2
2	029206	Tapón perfil superior	8	029212	Igualador Plisada
3	029217	Perfil aluminio	9	029202	Soporte techo plisada sistema cordón
4	029216	Perfil PVC	10	029226	Escuadra soporte pared Plisada
5	029215	Pasa cordón	11	029227	Escuadra separación Plisada
6	029209	Tapón perfil inferior	12	029203	Cordón Plisada 0,8

Medidas de fabricación

Máximos		Mínimos	
Ancho	2,30 m	Ancho	0,30 m
Alto	3,00 m	Alto	0,30 m



Tipos de sistemas

Sistema a cadena

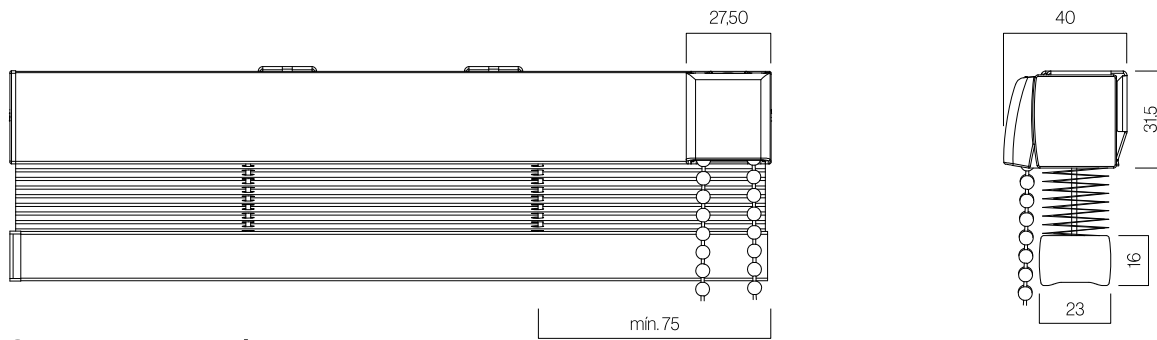

Sistema con tensión manual

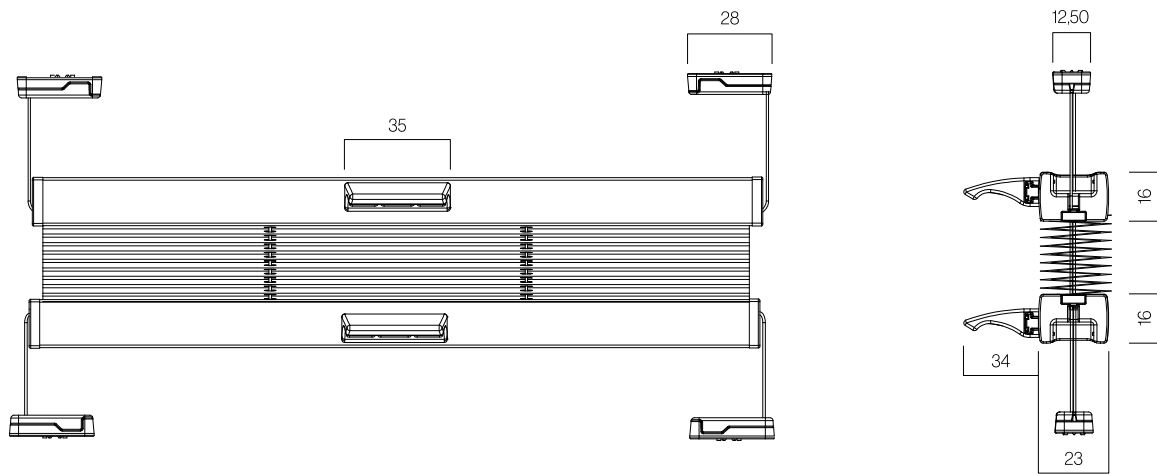

Sistema a cordón

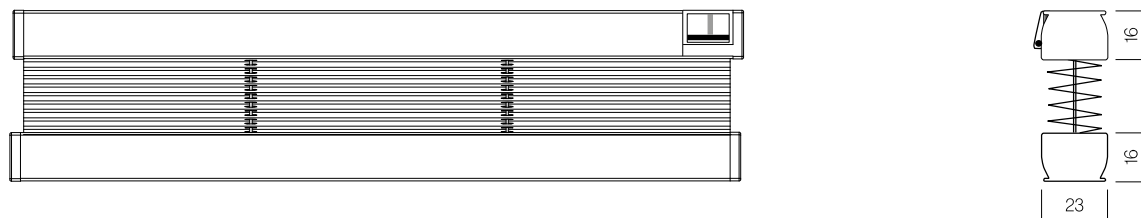

Soportes

Soportes para instalaciones a techo y a pared

Soporte techo
029202

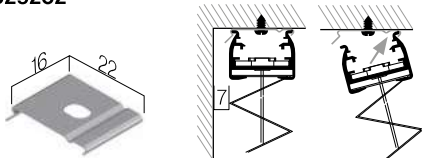

Escuadra separador
029227

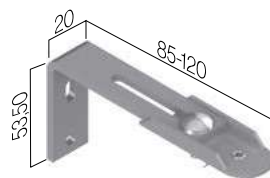

Soporte pared
029226

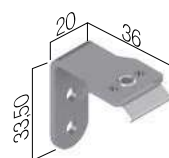

Soporte para cortina de cristal

Soporte superior

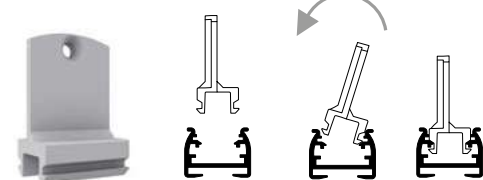

Jgo. soporte inferior

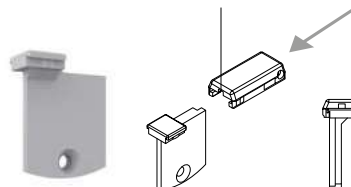

Tapa soporte



Medidas en mm.



Tipos de configuración

Configuraciones

Mecanismo a cordón.
Con guías laterales
(cordón).

101

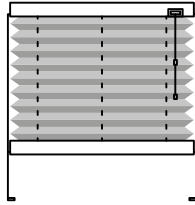

Mecanismo doble
cordón. Noche/día.

119

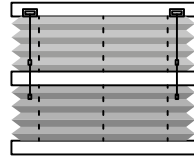

Accionamiento manual.
Con guías laterales
(cordón).

111

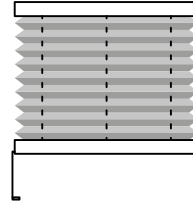

Accionamiento manual. Cierre
arriba/abajo
y abajo/arriba. Perfil de montaje
superior.

112

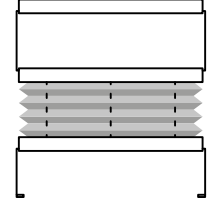

Accionamiento manual.
Noche/día.

113

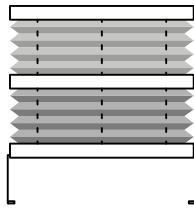

Accionamiento manual. Con
perfil de montaje inferior.

115

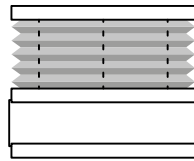

Accionamiento manual. No-
che/día con apertura central.

116

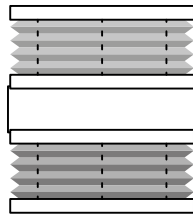

Accionamiento manual. Cierre
arriba/abajo
y abajo/arriba. Perfil de mon-
taje superior e inferior.

117

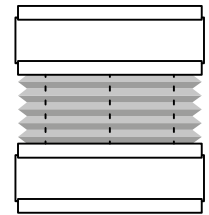

Configuraciones

Accionamiento ma-
nual. Noche/día con
perfil de montaje
inferior.

118

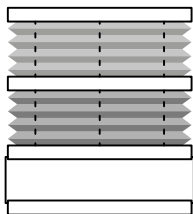

Accionamiento
manual. Apertura
central.

120

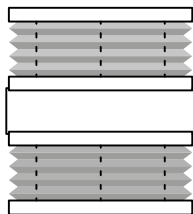

Accionamiento
manual. Cierre arri-
ba/abajo y abajo/
arriba.

140

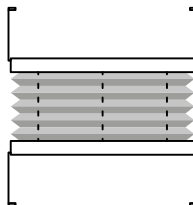

Máximo 1,30 ancho

121

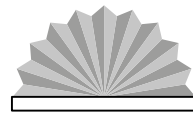

Máximo 0,70 ancho

121

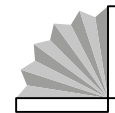

Máximo 1,30 ancho

122

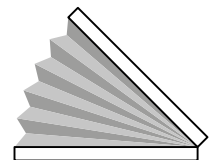

Características técnicas

Ancho máximo según el tipo de configuración

Nº configuración

111 • 112 • 113 • 114 • 115 • 116 • 117 • 118 • 119 • 120 • 140

Ancho máximo

1,20 m

Plisada Glass

029300 Sistema de 20 mm
Configuración 111 y 140

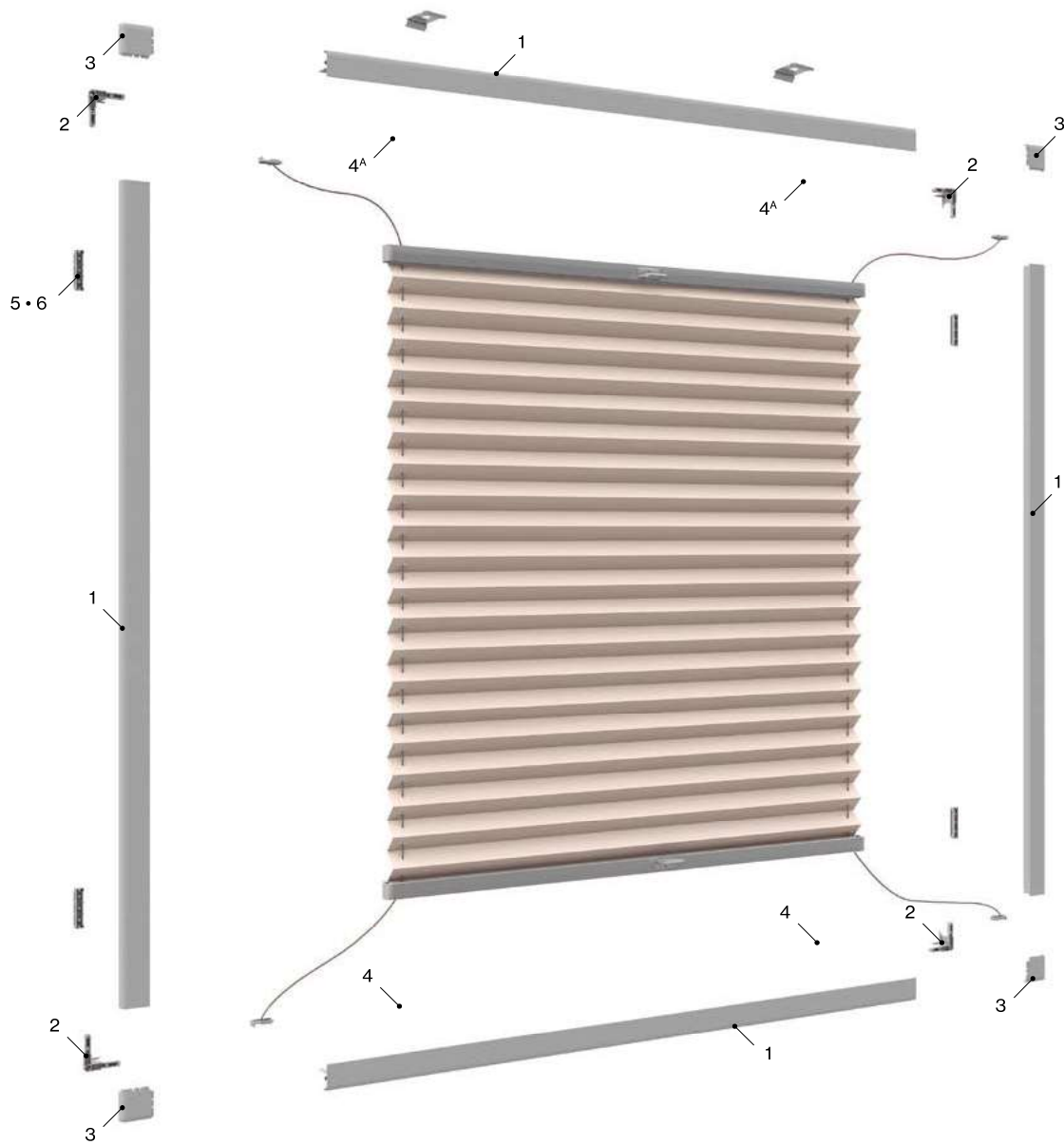

Componentes

Nº	Cód.	Descripción	Nº	Cód.	Descripción
1	031241	Perfil fácil ajuste 580 cm XS	4 ^A	031244	Tension shoe XS (configuración 140)
2	031242	Unión esquina XS	5	031251	Clip sujección ventana XS
3	031243	Cubierta esquina white ABS XS	6	031253	Cinta sujección ventana XS
4	031244	Tension shoe XS	7	029202	Soporte techo plisada sistema cordón

Medidas de fabricación

Máximos		Mínimos	
Ancho	1,20 m	Ancho	0,30 m
Alto	2,40 m	Alto	0,30 m

 Modelos

Plisada 27 Especial

029040 Sistema de 27 mm

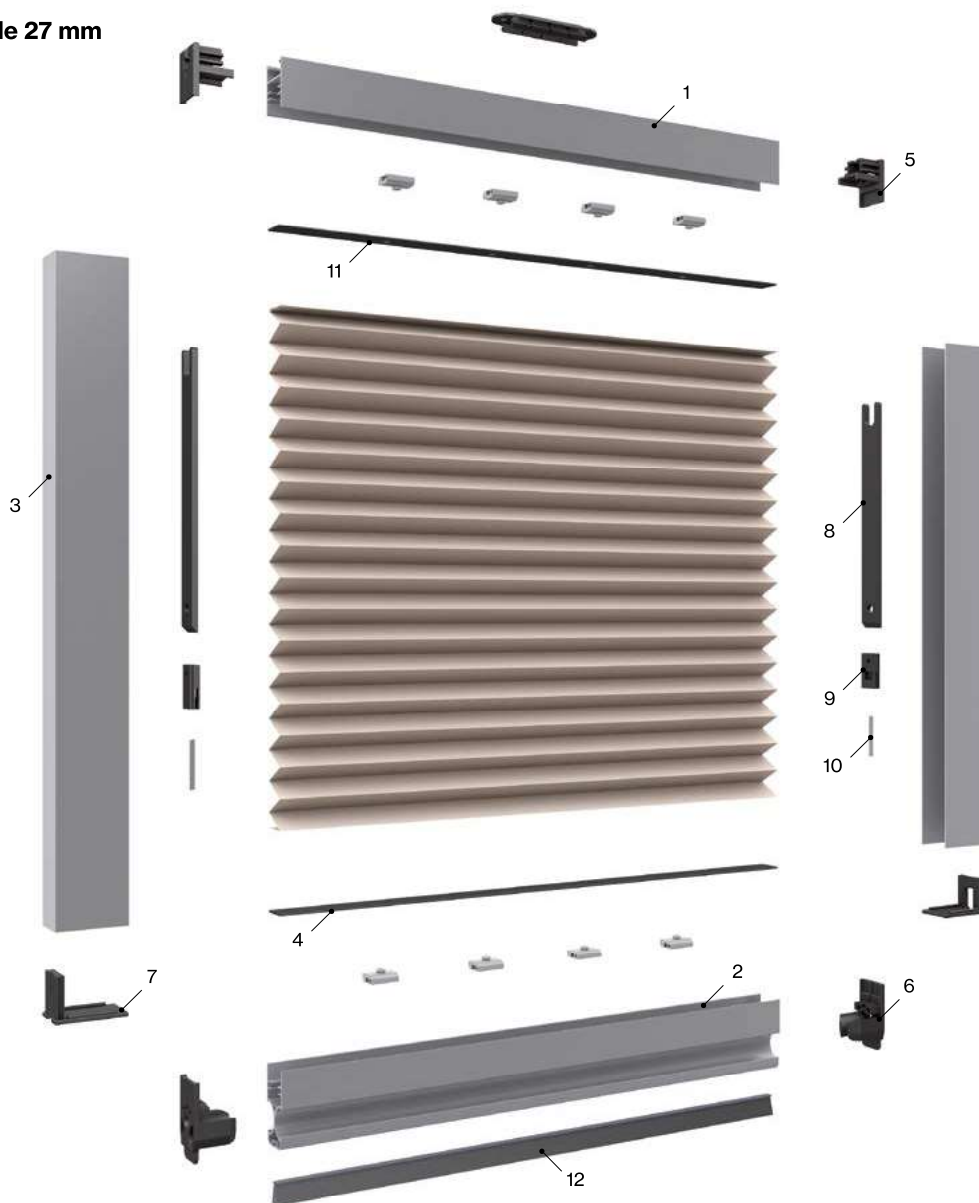

Componentes

Nº	Cód.	Descripción	Nº	Cód.	Descripción
1	042098	Perfil fijo 27	8	042126	Tope testero c/tornillo Vertical 27
2	042096	Perfil móvil 27	9	042113	Sujeción hilo con tuerca remachable 27
3	042099	Guía superior 27	10	042127	Muelle 27
4	042082	Tira PVC anclaje red H260	11	042084	Clip central 27
5	042124	Testero superior perfil fijo 27	12	042805	Felpudo 58-900
6	042125	Testero superior perfil pared	13	042023	Soporte mosquitera plisada
7	042123	Tapón inferior Vertical 27			

Medidas de fabricación

Máximos		Mínimos	
Ancho	1,60 m	Ancho	0,40 m
Alto	2,60 m	Alto	0,40 m



Características técnicas

Perfiles

Perfil móvil 27
042096

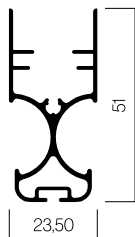

Guía superior 27
042099

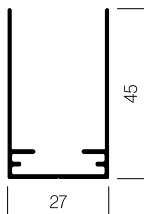

Perfil fijo 27
042098

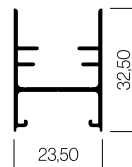

Guía Avant
031241

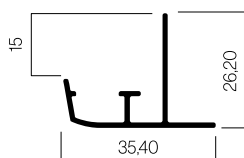

Tu mundo,
nuestro universo.