

CA cerramientos
abatibles

CA 20 TECHO FIJO

CA-20 TOITURE FIXE | **CA-20 FIXED ROOF**

44



 **TOL2JAVEA**
ESPACIOS PROTEGIDOS

 965 795 801  www.tol2javea.com



☎ 965 795 801 🌐 www.tol2javea.com

SECCIONES Y COTAS | Sections et Côtes | Section and Dimensions

COBIJA SUPERIOR, COBIJA INFERIOR |
ACCROCHE ARRIÈRE SUP, ACCROCHE ARRIÈRE INF |
TOP BLANKET, LOWER BLANKET

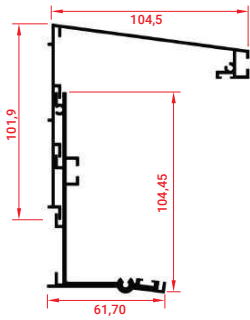

VIGA ESTRUCTURAL |
LINTEAU AVANT RENFORCÉ |
STRUCTURAL BEAM

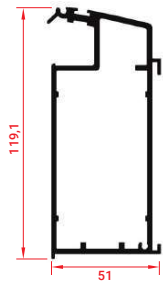

CANALÓN INFERIOR |
CHÉNEAU INFÉRIEUR |
BOTTOM GUTTER

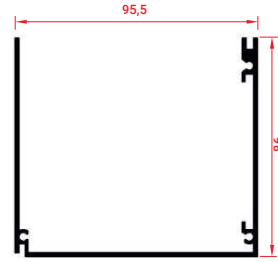

CANALÓN SUPERIOR |
CHÉNEAU SUPÉRIEUR |
UPPER GUTTER

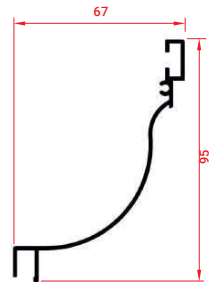

POSTE COLUMNA |
POTEAU | COLUMN POST

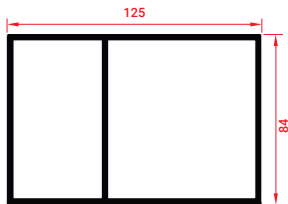

GUÍA 1 HOJAS |
GUIDE 1 RAILS |
GUIDE 1 SHEETS

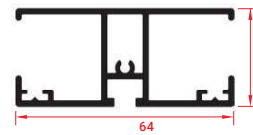
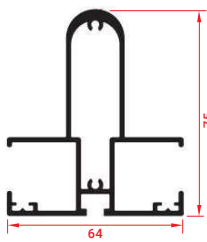





RANGOS DE USO

Gammes d'Utilisation

Ranges of Use

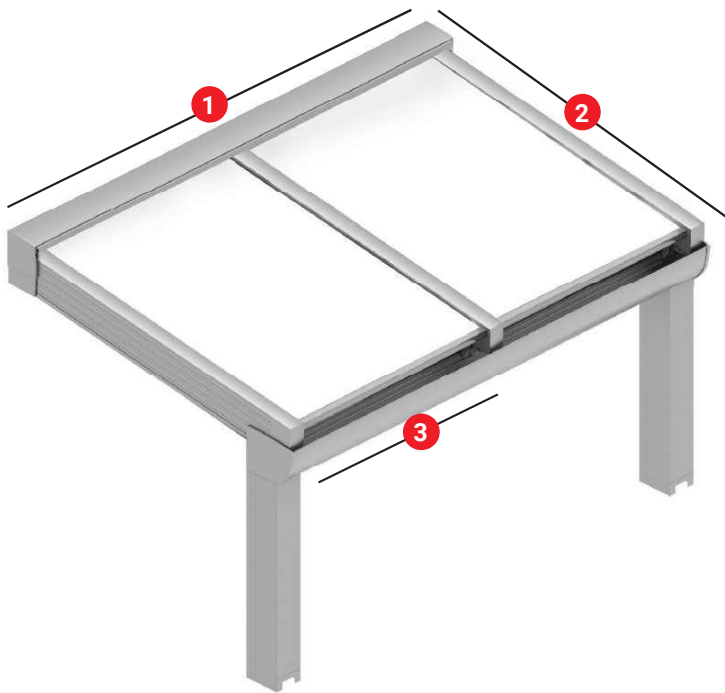

- 1 Línea Máxima: Infinita
- 2 Salida Máxima:
 - Cristal: 3.500 mm
 - Policarbonato: 4.000 mm
 - Panel Sándwich: 3.000 mm
- 3 Anchura máxima de calle: 1.200 mm

- 1 *Largueur totale: Pas de maximum*
- 2 *Max. profondeur/avancée:*
 - Verre: 3.500 mm
 - Polycarbonate: 4.000 mm
 - Panneau Sandwich: 3.000 mm
- 3 *Max. largeur par vantaux: 1.200 mm*

- 1 *Max. width: No Max.*
- 2 *Projection Max:*
 - Glass: 3.500 mm
 - Polycarbonate: 4.000 mm
 - Sandwich Panel: 3.000 mm
- 3 *Max. sheet width: 1.200 mm*

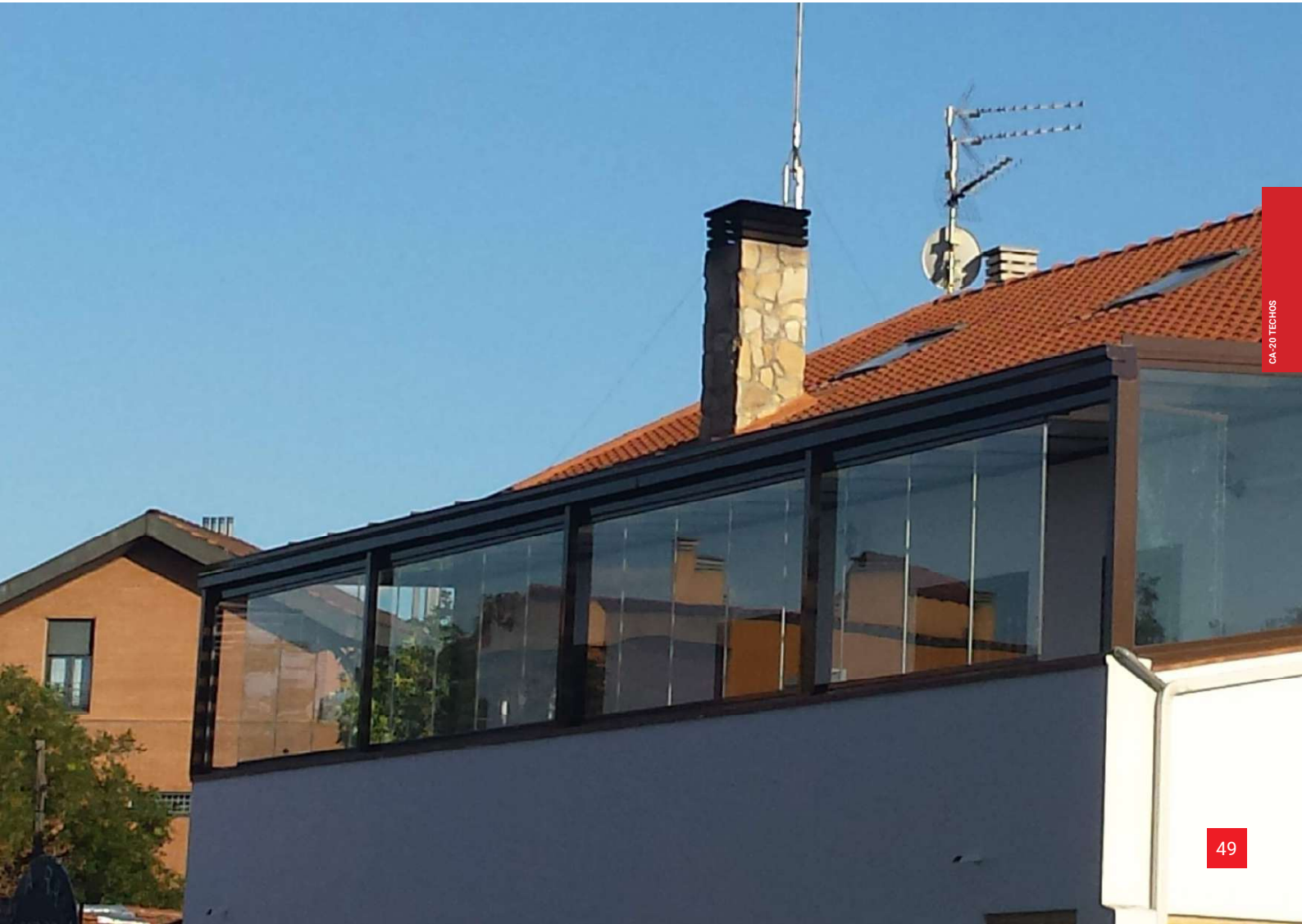





CA cerramientos
abatibles

TOL2JAVEA
ESPACIOS PROTEGIDOS

☎ 965 795 801 🌐 www.tol2javea.com

CA 20 **TECHO FIJO PLUS**

CA-20 TOITURE FIXE | **CA-20 FIXED ROOF**





SECCIONES Y COTAS

Sections et Côtes

Section and Dimensions

MONTANTE 100 |
MONTANT 100 |
UPRIGHT 100

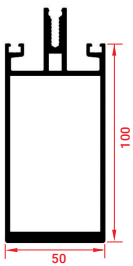

MONTANTE 125 |
MONTANT 125 |
UPRIGHT 125

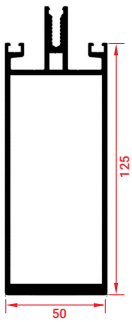

MONTANTE 150 |
MONTANT 150 |
UPRIGHT 150

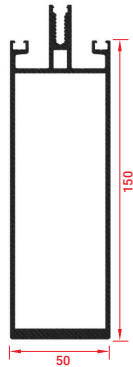

MONTANTE 175 |
MONTANT 175 |
UPRIGHT 175

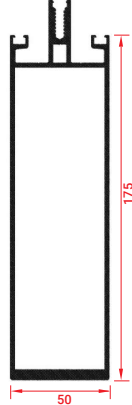

MONTANTE 200 |
MONTANT 200 |
UPRIGHT 200

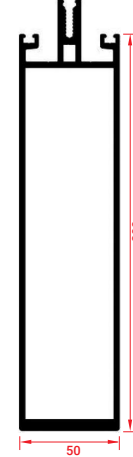

MONTANTE 225 |
MONTANT 225 |
UPRIGHT 225

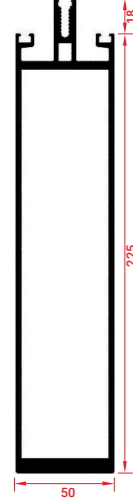

TRAVESAÑO | BARRE
TRANSVERSALE (TRAVERS) |
CROSS-PIECE

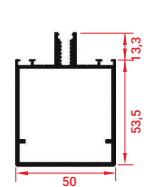

CANALÓN SUPERIOR |
CHÉNEAU SUPÉRIEUR |
UPPER GUTTER

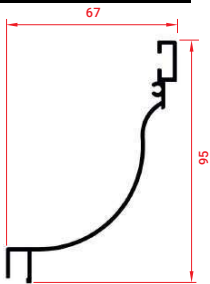

POSTE COLUMNA |
POTEAU | COLUMN POST

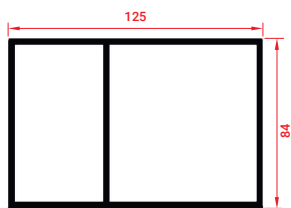

CANALÓN INFERIOR |
CHÉNEAU INFÉRIEUR |
BOTTOM GUTTER

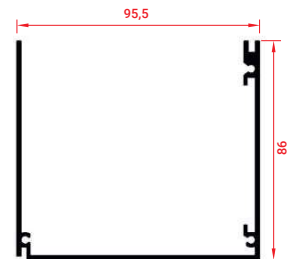





RANGOS DE USO

Gammes d'Utilisation

Ranges of Use

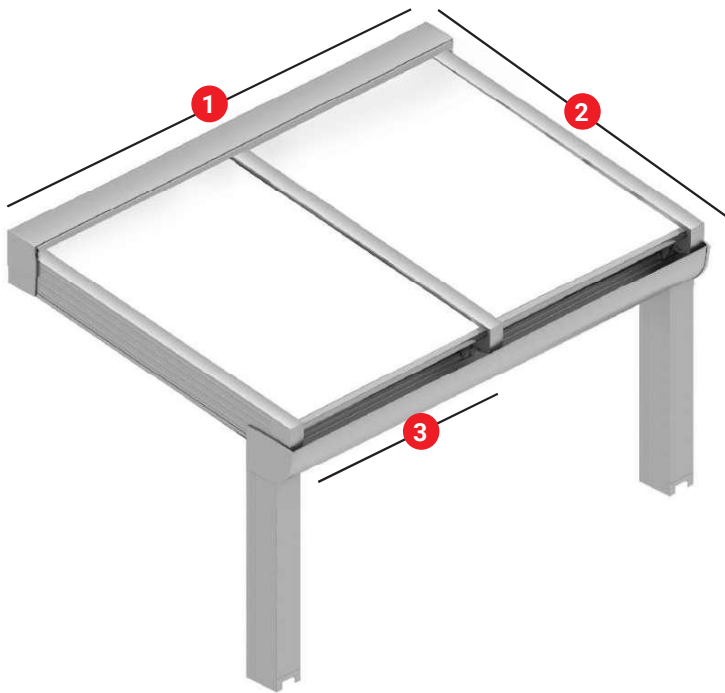

- 1 Línea Máxima: Infinita
- 2 Salida Máxima: 6.500 mm
- Cristal, Policarbonato, Panel Sándwich
- 3 Anchura máxima de calle: 1.200 mm

- 1 *Largeur totale: Pas de maximum*
- 2 *Max. profondeur/avancée: 6.500 mm*
- Verre, Polycarbonate, Panneau Sandwich
- 3 *Max. largeur par vantaux: 1.200 mm*

- 1 *Max. width: No Max.*
- 2 *Projection Max: 6.500 mm*
- Glass, Polycarbonate, Sandwich Panel
- 3 *Max. sheet width: 1.200 mm*





☎ 965 795 801 🌐 www.tol2javea.com



